



# EMPRESS ROUND BABY BASSINET

**Assembly Instructions. Adult Assembly Required.**  
**Read all instructions before use. This manual is part of the product and must be kept for future reference.**



## **MODEL NUMBERS\*:**

- 83901 - Pink/White
- 83902 - White with Three Belts
- 83903 - Ecru/Leaf Print
- 83904 - Gray

## **VERSION CODE\*:**

**4.0/0819/TG**

*\* Model and Version numbers are needed if replacement parts are requested*

Find us on  •  **YouTube** *assembly video available at Badger Basket's YouTube channel!*

**FOR REPLACEMENT PARTS:**  
<http://www.badgerbasket.com/parts>

Badger Basket®, PO Box 227, Edgar, WI 54426-0227 USA • **Web:** [www.badgerbasket.com](http://www.badgerbasket.com)  
**U.S. Based Customer Service Toll-Free** (Mon-Thurs 7:00 AM-4:00 PM CST): 1-800-236-1310  
**Phone:** 715-352-2311 • **Fax:** 715-352-3163



**NOTE: Assemble your Empress bassinet in the room where you intend to use it unless your doorways are wider than 30 inches.**

**BEFORE YOU BEGIN ASSEMBLY:**

Check all parts and hardware. If anything is missing or not satisfactory, please DO NOT call the store or return the product to them. Please go online to

**<http://www.badgerbasket.com/parts>**

for assistance. Most problems are resolved promptly without you needing to leave home. When contacting us, please have this instruction manual, your product model number, and your product version code ready.

**Your Product Model Number: See Cover Page**

**Your Product Version Code is: 4.0/0819/TG**

**CARE INSTRUCTIONS:**

Wipe bassinet frame and vinyl/foam mattress clean with a damp cloth and mild detergent as needed. Bedding can be machine washed on cold, gentle cycle, and air dried or tumble dry on low or no heat. Iron on lowest setting for polyester/cotton.

Secure all snaps/straps/tabs before washing.

Additional fitted sheets are available and sold separately.

White Sheets (2/pack) are Model #83998

Ecru Sheets (2/pack) are Model #83997



# WARNING

## FAILURE TO FOLLOW THESE WARNINGS AND THE INSTRUCTIONS COULD RESULT IN DEATH OR SERIOUS INJURY

**FALL HAZARD**—To help prevent falls, do not use this product when the infant begins to push up on hands and knees or has reached **20 lbs. (9.09 kg)**, whichever comes first.

- **SUFFOCATION HAZARD** Babies have suffocated:
- In gaps between extra padding and side of the bassinet/ cradle, and
- On soft bedding

**NEVER** add a mattress, pillow, comforter, or padding. Use **ONLY** the pad and/or bedding provided by the manufacturer. If a sheet is used with the pad, use only the one provided with the bassinet or one that is from Badger Basket® or one that is specifically designed to fit the dimension of the mattress provided.

**ALWAYS** use a sheet that fits securely on the mattress and wraps around the mattress corners. Only a fitted sheet, mattress pad and/or waterproof pad should be used under the baby.

- **FALL HAZARD**—Always check that the bassinet is securely locked on the base/stand by pulling upwards on the bassinet bed.
- Use **ONLY** the bedding designed for this bassinet from Badger Basket®. Secure the bedding as instructed in this manual and check regularly to ensure it remains properly attached.
- **READ ALL INSTRUCTIONS** before use of this product.
- Keep instructions for future use.
- Use only the parts and hardware provided by Badger Basket®.
- Hardware may include small parts. **Choking Hazard!** Keep unassembled parts out of the reach of small children.
- Do not use if any part of the bassinet is broken, torn, or missing.
- **TO REDUCE THE RISK OF SIDS:** pediatricians recommend that healthy infants be placed on their backs to sleep, unless otherwise advised by your physician.
- **DO NOT** move or carry the bassinet with your baby inside of it.
- **DO NOT** allow other children or pets to climb or lean into or onto the bassinet when your infant is inside.
- Strings can cause strangulation! Do not place items with a string around a child's neck, such as hood strings or pacifier cords. Do not suspend strings over a bassinet or cradle or attach strings to toys.
- **Keep bassinet away** from stoves, heaters, camp fires/flames, fireplaces, stairs, open windows, running or standing water, and any other hazard which could cause injury to your baby.
- **Be sure** that your baby's sleep space is a safe distance from windows and any curtains, shades, blinds, or window coverings or decorations that may pose a danger from dangling or loose fabrics and cords.
- **NEVER** use plastic bags inside the basket such as to cover the mattress.
- **Bassinet should always** be placed on a firm, flat surface. It should never be placed near stairs or on tables or elevated surfaces.
- No product is a replacement for adult supervision.
- **DO NOT** allow anyone to climb, stand on, or play on or inside of this product. It is not a step stool or ladder.
- **BE AWARE** of what items are in the area around the bassinet that your child can reach, grab, or pull that could be a choking, electrical, strangulation, injury, or other type of hazard.
- **DO NOT** make adjustments to the bassinet while child is inside.
- **NEVER** place the bassinet near fire nor open flame nor other sources of intense heat.
- **NEVER** place infants to sleep on pillows, sofa cushions, adult beds, waterbeds, beanbags, or any other surface not specifically designed for infant sleep.
- **Remove** pillows, sheepskins, pillow-like stuffed toys and products not intended as infant bedding from the bassinet when your infant is sleeping.
- **Do not** overdress your baby. Cover the baby with a thin covering, such as a crib blanket, receiving blanket or other blanket specifically designed for infants, which covers only up to the baby's chest, and tuck the covering around the mattress. For newborns, consider swaddling. Consider using a wearable blanket.
- **Check** periodically for loose threads or stitching which could cause gagging or choking.

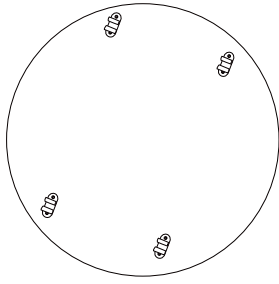

**BOTTOM**  
A×1

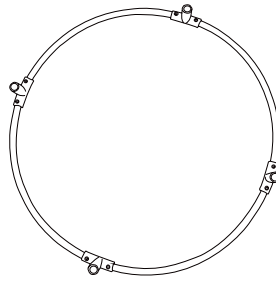

**TOP RING WITH  
FOAM PADDING**  
B×1

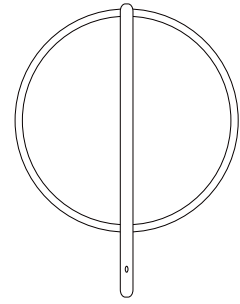

**CANOPY HOOP**  
C×1

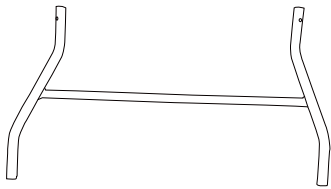

**LOWER LEG**  
D×2

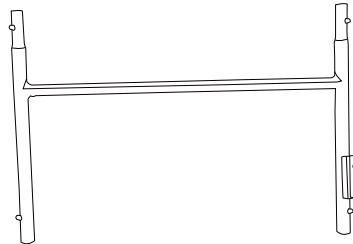

**REAR UPPER LEG**  
E×1

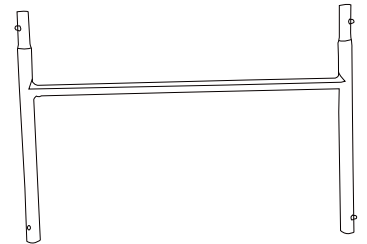

**FRONT UPPER LEG**  
F×1

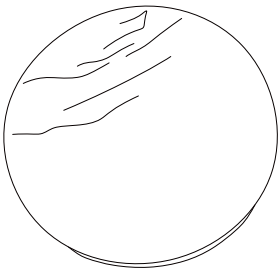

**VINYL/FOAM PAD**  
G×1

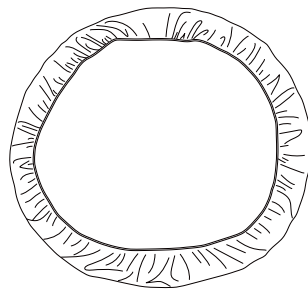

**FITTED FABRIC SHEET**  
H×1



**FABRIC LINER/SKIRT**  
I×1



**FABRIC CANOPY**  
J×1

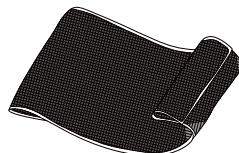

**MESH SHELF**  
K×1

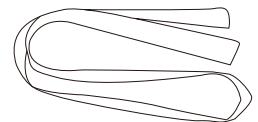

Does not apply to all models.  
Only applies to bedding  
sets with belt loops  
on the liner around the top  
rim of the bassinet.

**BELT**  
M×1



**CANOPY POLE**  
L×1



**WHEELS**  
N×4

**DO NOT REMOVE THE FOAM PADDING FROM THE METAL FRAME. THIS IS INTENTIONAL, IS A VITAL PART OF THE BASSINETS FRAME AND IS NOT PACKING MATERIAL.**



1

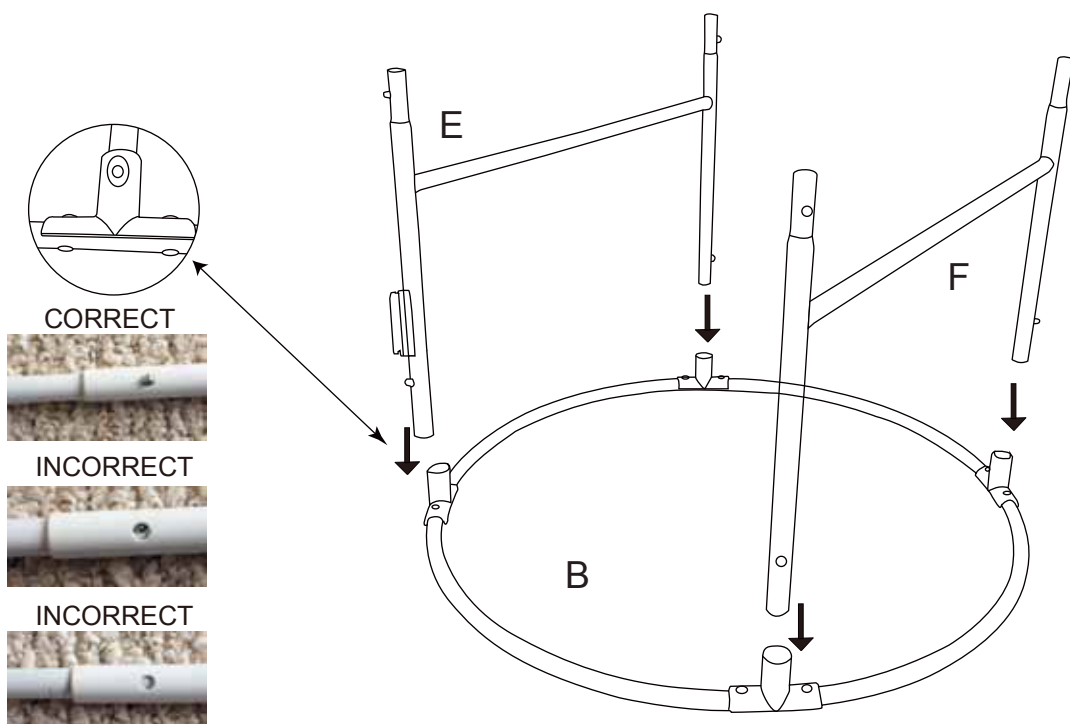



2

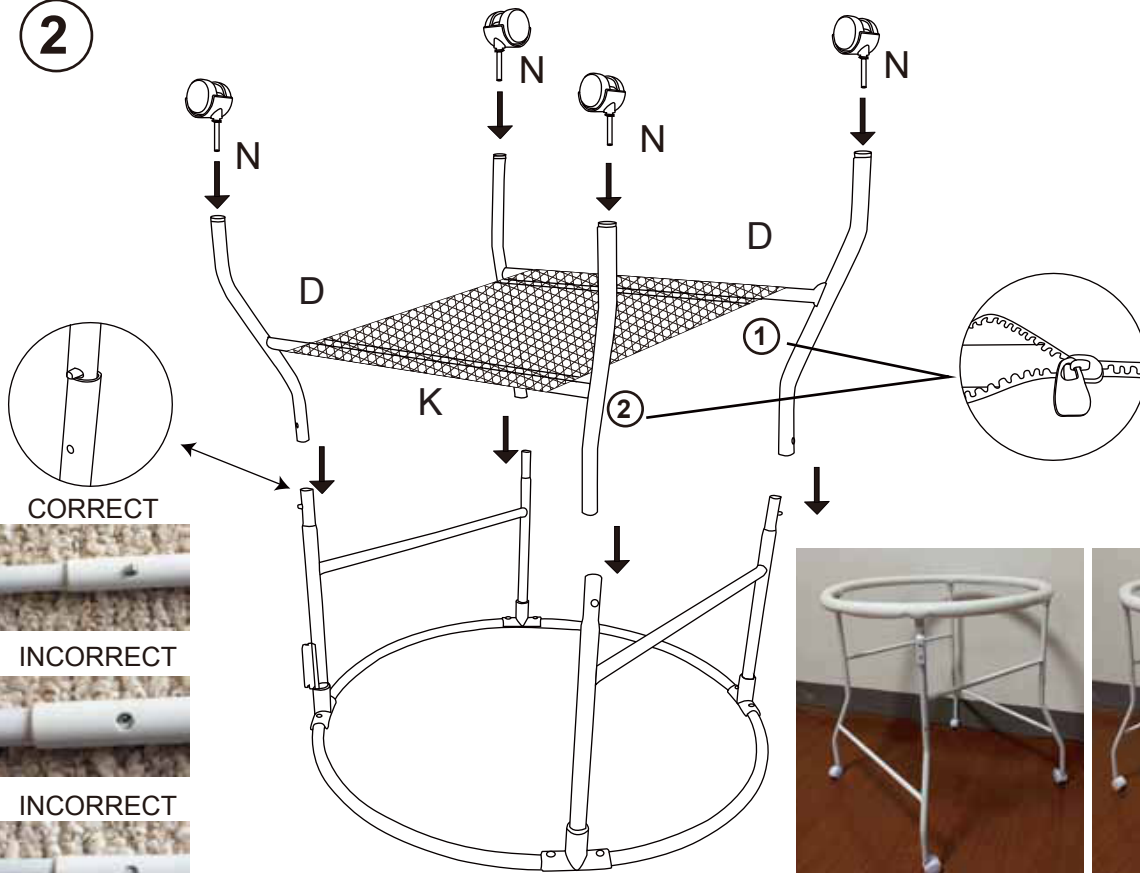

CORRECT ✓ INCORRECT ✗

3

Position the FABRIC LINER/SKIRT (I) onto the bassinet frame with the zippers open. Then wrap the zippers around the metal frame, and zip them shut to securely attach the liner to the frame. Regularly check the zippers to be sure they remain secure.



Make sure insert pin is inserted fully into the retaining box prior to pulling zipper.



**WARNING!**  
To prevent injury from falls or sliding out, you must read and follow all directions in the assembly manual! Be sure that all of the zippers on the bedding, that go around the bassinet frame, are zipped to keep the liner secure!

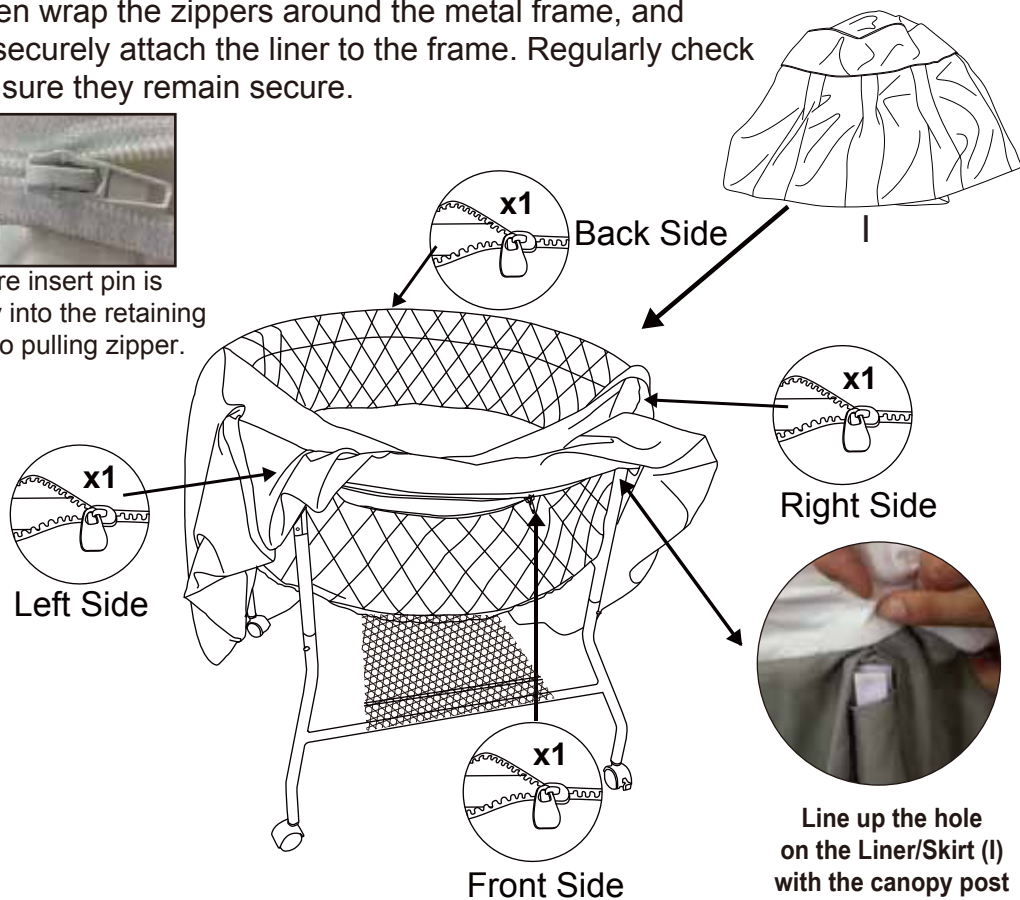

Line up the hole on the Liner/Skirt (I) with the canopy post on the Leg (E).

4



“WARNING: Make sure that ALL 8 red safety snaps are secured after the zippers are properly zipped”

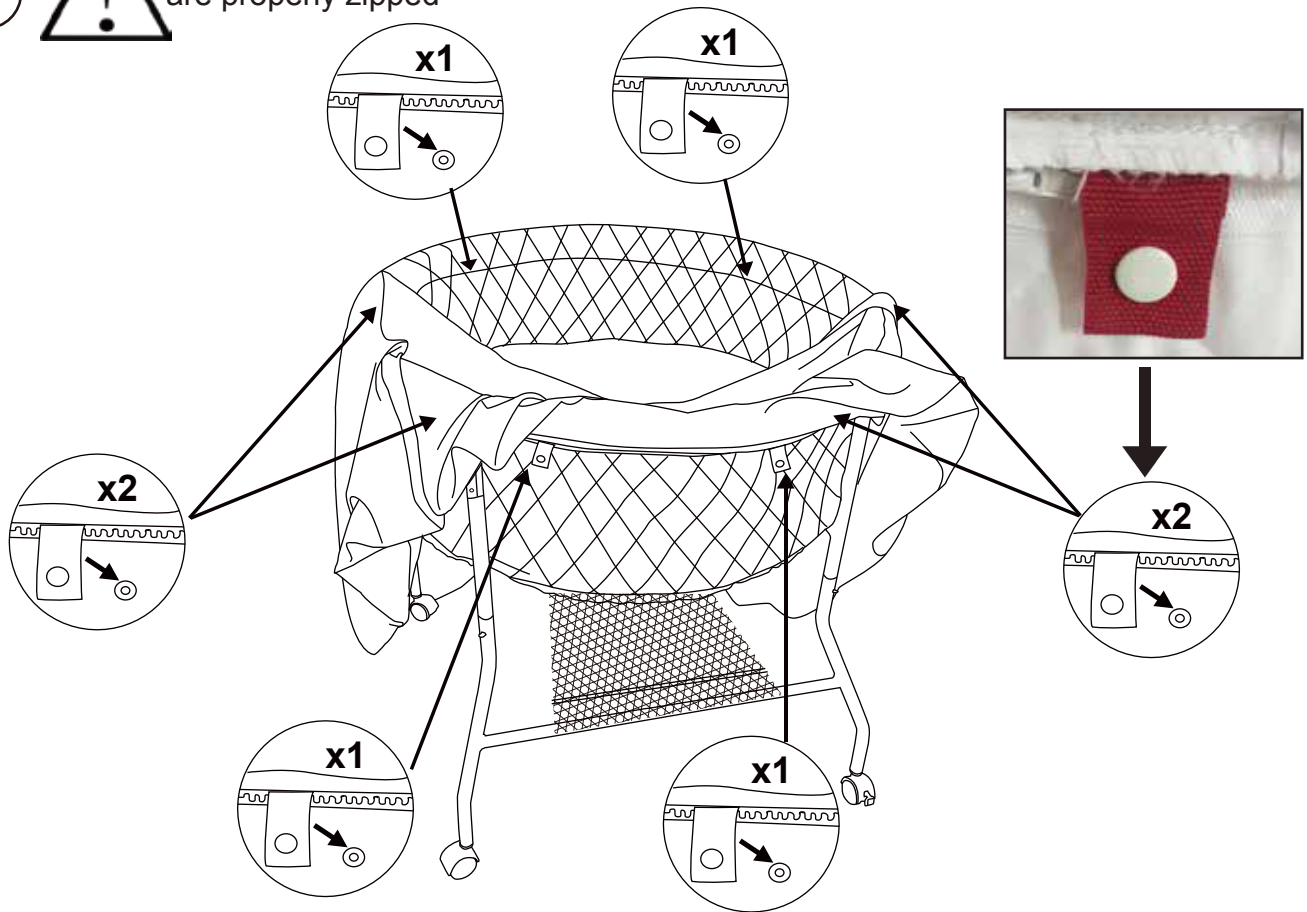

5

Insert the BOTTOM (A). Push the clips through the holes in the fabric and snap them securely to the UPPER LEGS (E and F). It is helpful to have assistance with this step to apply pressure to the BOTTOM (A) on the inside while you position and snap the clips on the outside.

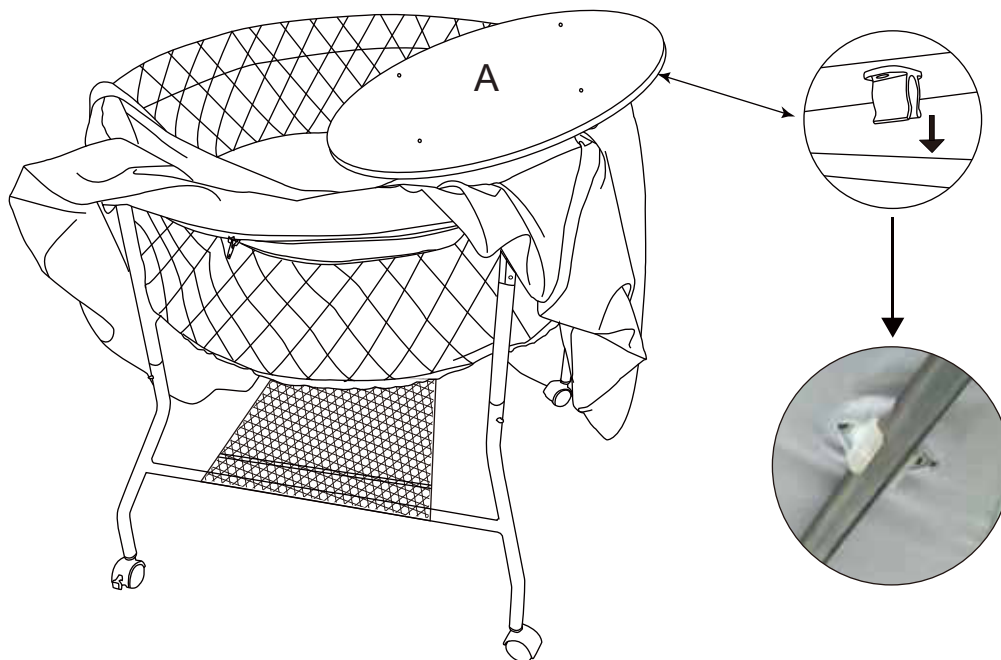

6

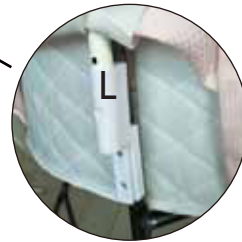
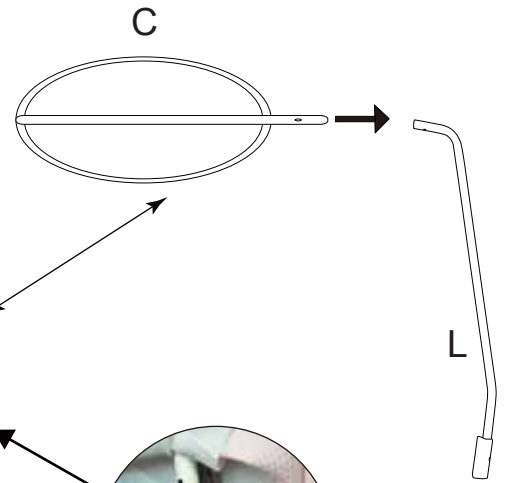
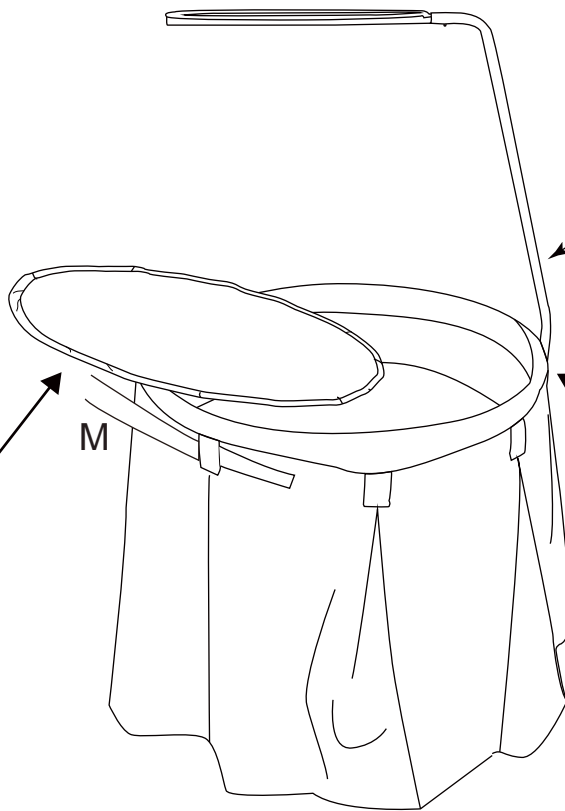
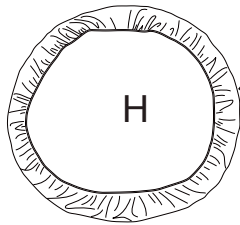
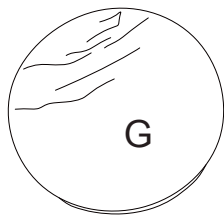

7

