



## WISHES BABY BASSINET

**Assembly Instructions. Adult Assembly Required.**  
**Read all instructions before use. This manual is part of the product and must be kept for future reference.**

### **MODEL NUMBERS\*:**

- 31001 - White
- 31002 - Gray
- 31004 - White/Gray Belt
- 31005 - Gray/Leaf
- 31006 - Gray/Lantern

### **VERSION CODE\*:**

**3.0/0819/TG**

*\* Model and Version numbers are needed  
if replacement parts are requested*



Find us on  •  **YouTube** *assembly video available at Badger Basket's YouTube channel!*

**FOR REPLACEMENT PARTS:**  
<http://www.badgerbasket.com/parts>

Badger Basket®, PO Box 227, Edgar, WI 54426-0227 USA • **Web:** [www.badgerbasket.com](http://www.badgerbasket.com)  
**U.S. Based Customer Service Toll-Free** (Mon-Thurs 7:00 AM-4:00 PM CST): 1-800-236-1310  
**Phone:** 715-352-2311 • **Fax:** 715-352-3163



**BEFORE YOU BEGIN ASSEMBLY:**

Check all parts and hardware. If anything is missing or not satisfactory, please DO NOT call the store or return the product to them. Please go online to

**<http://www.badgerbasket.com/parts>**

for assistance. Most problems are resolved promptly without you needing to leave home. When contacting us, please have this instruction manual, your product model number, and your product version code ready.

**Your Product Model Number: See Cover Page**

**Your Product Version Code is: 3.0/0819/TG**

**CARE INSTRUCTIONS:**

Wipe bassinet frame and vinyl/foam pad clean with a damp cloth and mild detergent as needed. Bedding can be unzipped and removed from the frame. Basket and fitted sheet can also be removed for washing. Machine wash cold water, gentle cycle, and air dry or tumble dry on low or no heat. Iron on lowest setting for polyester/cotton. Secure all snaps/straps/tabs before washing.

Additional fitted sheets are available and sold separately.  
White Sheets (2/pack) are Badger Basket Model #31003.



# WARNING

## FAILURE TO FOLLOW THESE WARNINGS AND THE INSTRUCTIONS COULD RESULT IN DEATH OR SERIOUS INJURY

**FALL HAZARD**—To help prevent falls, do not use this product when the infant begins to push up on hands and knees or has reached **20 lbs. (9.09 kg)**, whichever comes first.

- **SUFFOCATION HAZARD** Babies have suffocated:
  - In gaps between extra padding and side of the bassinet/ cradle, and
  - On soft bedding

**NEVER** add a mattress, pillow, comforter, or padding. Use **ONLY** the pad and/or bedding provided by the manufacturer. If a sheet is used with the pad, use only the one provided with the bassinet or one that is from Badger Basket® or one that is specifically designed to fit the dimension of the mattress provided.

**ALWAYS** use a sheet that fits securely on the mattress and wraps around the mattress corners. Only a fitted sheet, mattress pad and/or waterproof pad should be used under the baby.

- **FALL HAZARD**—Always check that the bassinet is securely locked on the base/stand by pulling upwards on the bassinet bed.
- Use **ONLY** the bedding designed for this bassinet from Badger Basket®. Secure the bedding as instructed in this manual and check regularly to ensure it remains properly attached.
- **READ ALL INSTRUCTIONS** before use of this product.
- Keep instructions for future use.
- Use only the parts and hardware provided by Badger Basket®.
- Hardware may include small parts. **Choking Hazard!** Keep unassembled parts out of the reach of small children.
- Do not use if any part of the bassinet is broken, torn, or missing.
- **TO REDUCE THE RISK OF SIDS:** pediatricians recommend that healthy infants be placed on their backs to sleep, unless otherwise advised by your physician.
- **DO NOT** move or carry the bassinet with your baby inside of it.
- **DO NOT** allow other children or pets to climb or lean into or onto the bassinet when your infant is inside.
- Strings can cause strangulation! Do not place items with a string around a child's neck, such as hood strings or pacifier cords. Do not suspend strings over a bassinet or cradle or attach strings to toys.
- **Keep bassinet away** from stoves, heaters, camp fires/flames, fireplaces, stairs, open windows, running or standing water, and any other hazard which could cause injury to your baby.
- **Be sure** that your baby's sleep space is a safe distance from windows and any curtains, shades, blinds, or window coverings or decorations that may pose a danger from dangling or loose fabrics and cords.
- **NEVER** use plastic bags inside the basket such as to cover the mattress.
- **Bassinet should always** be placed on a firm, flat surface. It should never be placed near stairs or on tables or elevated surfaces.
- No product is a replacement for adult supervision.
- **DO NOT** allow anyone to climb, stand on, or play on or inside of this product. It is not a step stool or ladder.
- **BE AWARE** of what items are in the area around the bassinet that your child can reach, grab, or pull that could be a choking, electrical, strangulation, injury, or other type of hazard.
- **DO NOT** make adjustments to the bassinet while child is inside.
- **NEVER** place the bassinet near fire nor open flame nor other sources of intense heat.
- **NEVER** place infants to sleep on pillows, sofa cushions, adult beds, waterbeds, beanbags, or any other surface not specifically designed for infant sleep.
- **Remove** pillows, sheepskins, pillow-like stuffed toys and products not intended as infant bedding from the bassinet when your infant is sleeping.
- **Do not** overdress your baby. Cover the baby with a thin covering, such as a crib blanket, receiving blanket or other blanket specifically designed for infants, which covers only up to the baby's chest, and tuck the covering around the mattress. For newborns, consider swaddling. Consider using a wearable blanket.
- **Check** periodically for loose threads or stitching which could cause gagging or choking.

A×2

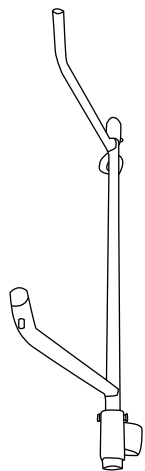

LEG

B×1

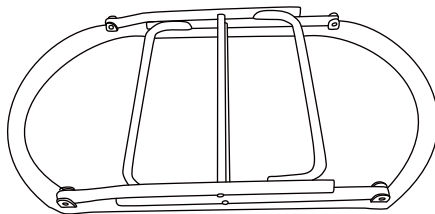

BODY

C×1

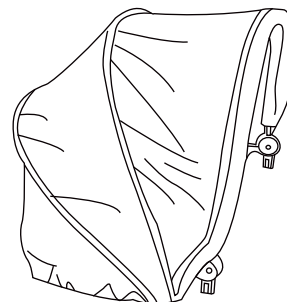

CANOPY

D×1

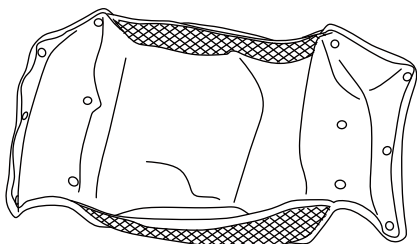

BASKET

E×1

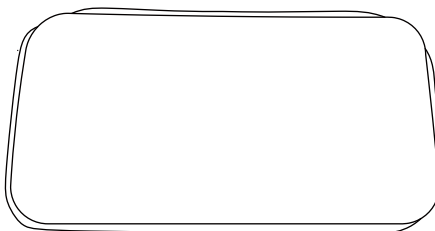

BODY WITH FOAM PADDING

F×1

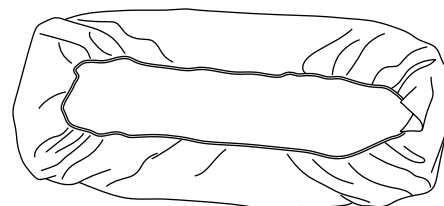

FITTED SHEET

G×1

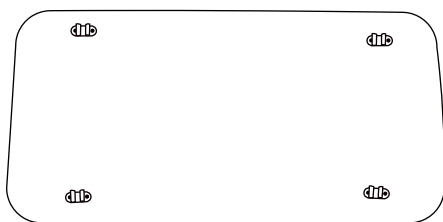

BOTTOM

H×1

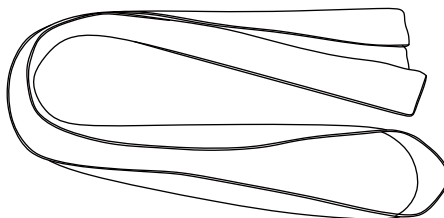

Does not apply to all models. Only applies to bedding sets with belt loops on the liner around the top rim of the bassinet.

BELT

I×1

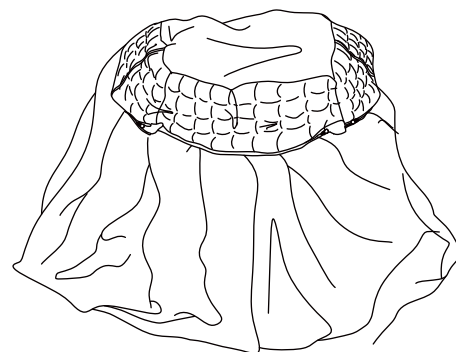

LINER/SKIRT

**DO NOT REMOVE THE FOAM PADDING FROM THE METAL FRAME. THIS IS INTENTIONAL, IS A VITAL PART OF THE BASSINETS FRAME AND IS NOT PACKING MATERIAL.**



1

Unfold the BODY (B) and attach both of the LEGS (A). The wheels rotate and can be locked in the cradle position (the bassinet will rock) or in the bassinet position (the bassinet is stationary). Rotate the wheels by gently pulling the wheel assembly out towards the end of the leg post, rotate the wheel to the up or down position as desired, and then let the wheel snap back into place on the leg post. **!! WARNING: After adjusting each wheel, you MUST make sure all the wheels are held in position by the locking posts.**

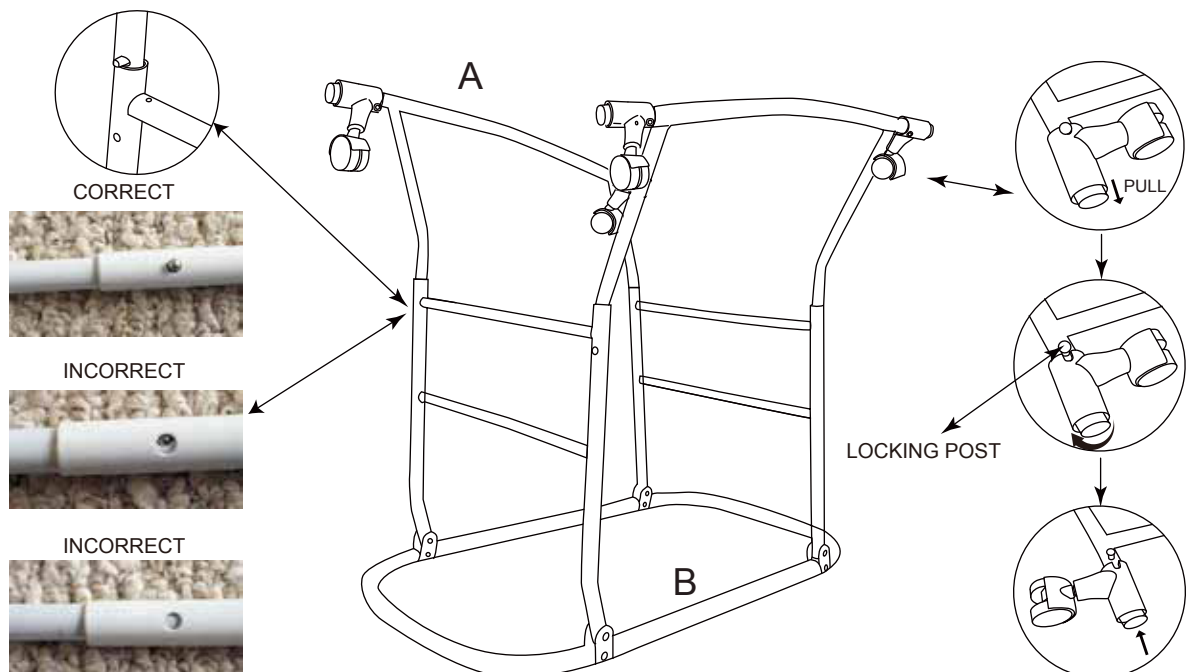

2

Turn the BODY(B) right side up. Secure the BASKET (D) to the BODY (B).

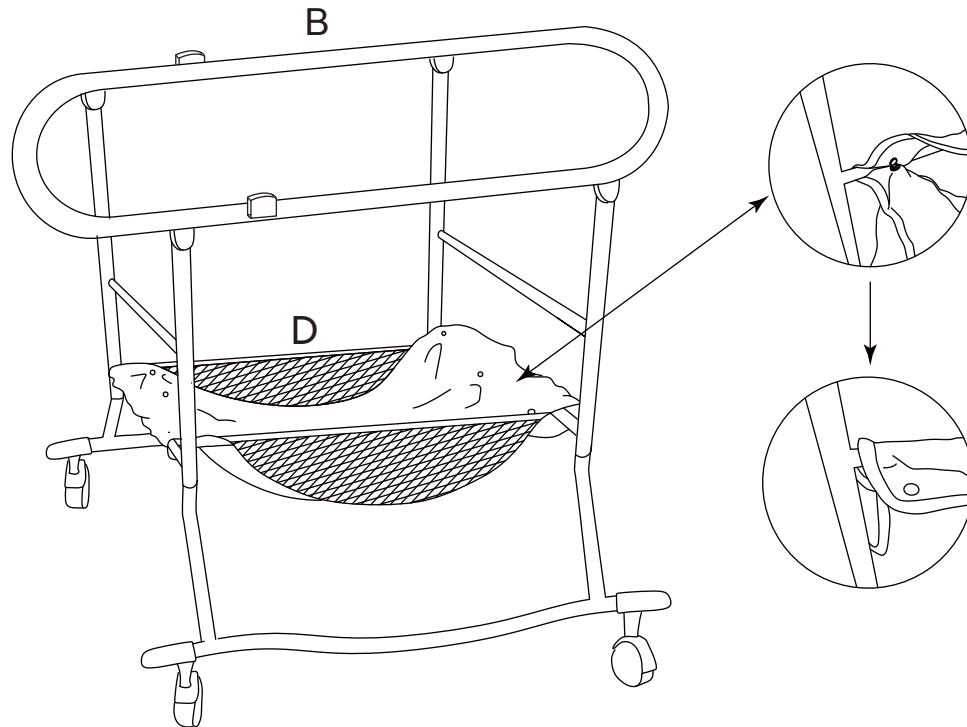

3

Unfold the LINER/SKIRT (I) and position it on the frame. Then zip all of the zippers around the top rim of the bassinet on all sides around the BODY (B).



Make sure insert pin is inserted fully into the retaining box prior to pulling zipper.



**READ AND FOLLOW ALL DIRECTIONS IN THE ASSEMBLY MANUAL! BE SURE THAT ALL OF THE ZIPPERS ON THE BEDDING, THAT GO AROUND THE BASSINET FRAME, ARE ZIPPED TO KEEP THE LINER SECURE!**

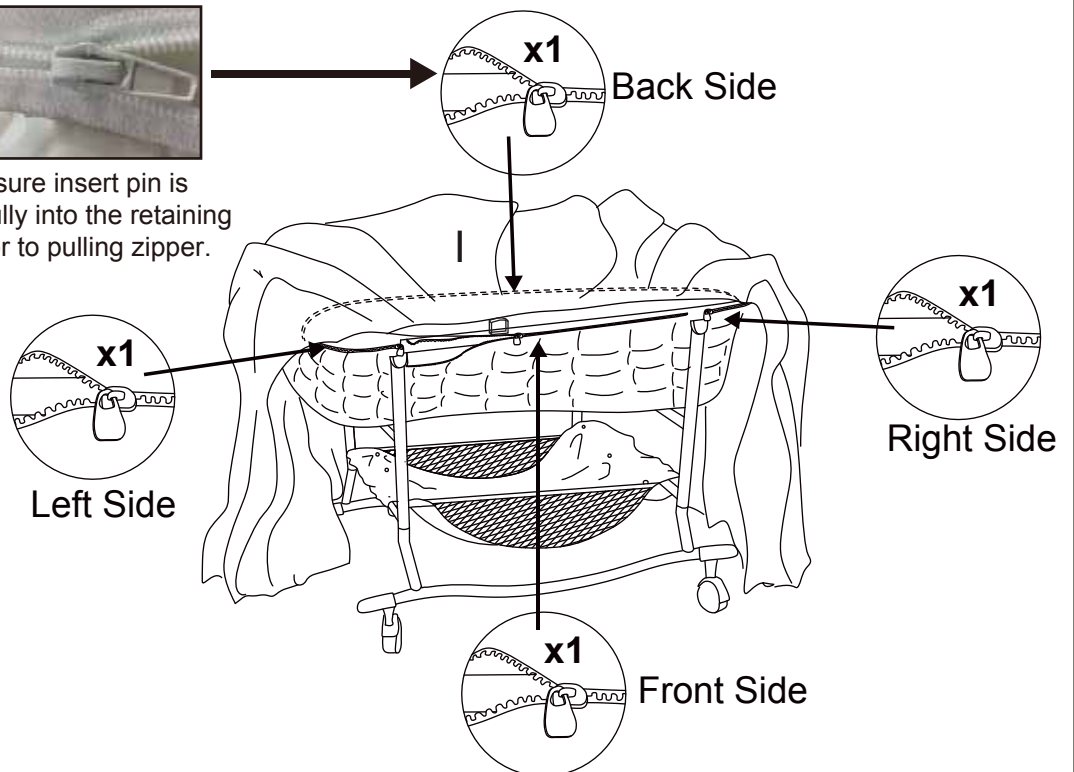

4



“WARNING: Make sure that ALL 8 red safety snaps are secured after the zippers are properly zipped”

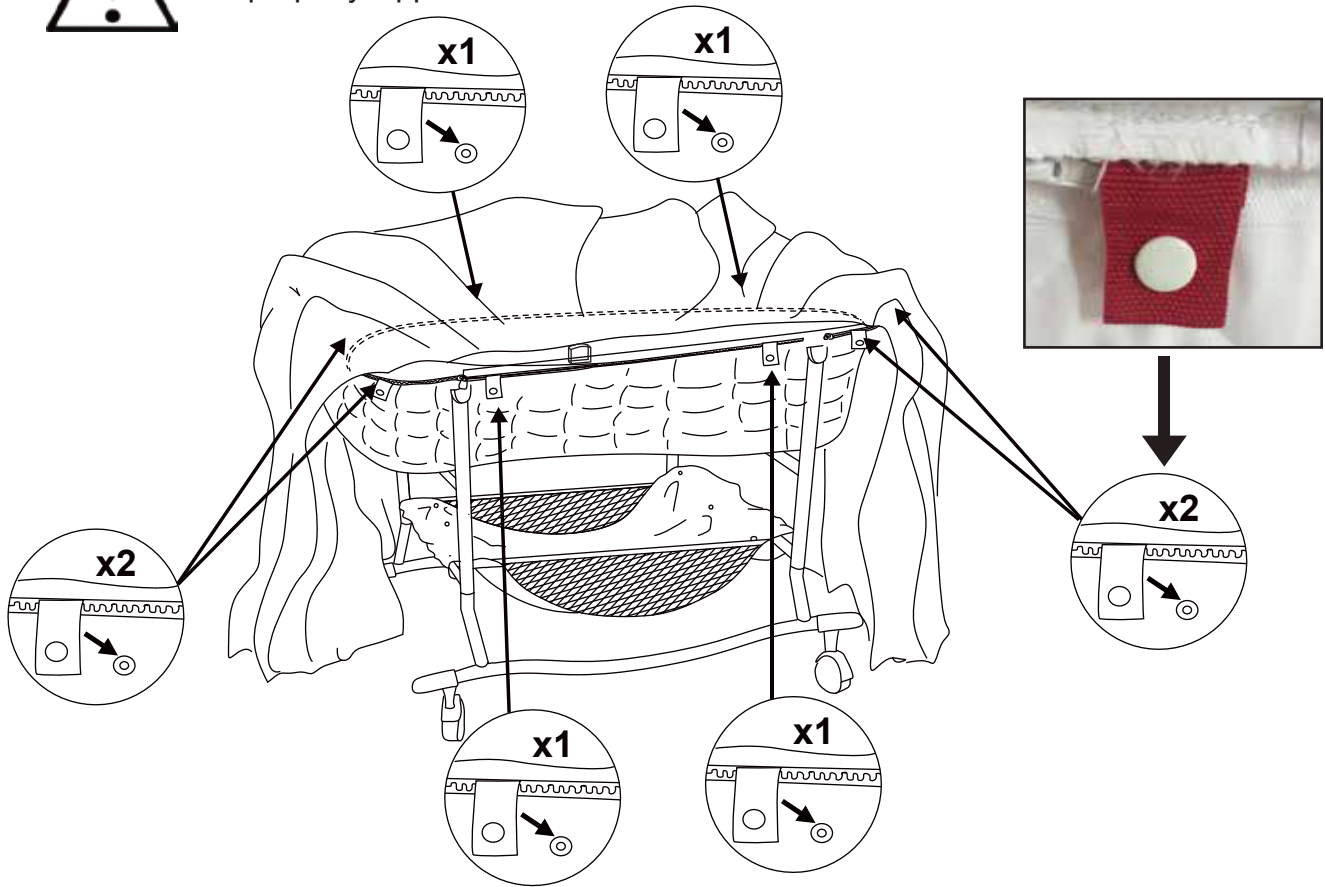

5

Insert the BOTTOM (G). Push the clips through the holes in the fabric. Position the clips on the outside. Then apply pressure to BOTH SIDES of the BOTTOM (G) on the inside at the same time to snap the clips into place.



It is helpful to have assistance with this step so one person can position the clips on the outside and then the second person can apply pressure to both sides on the inside.

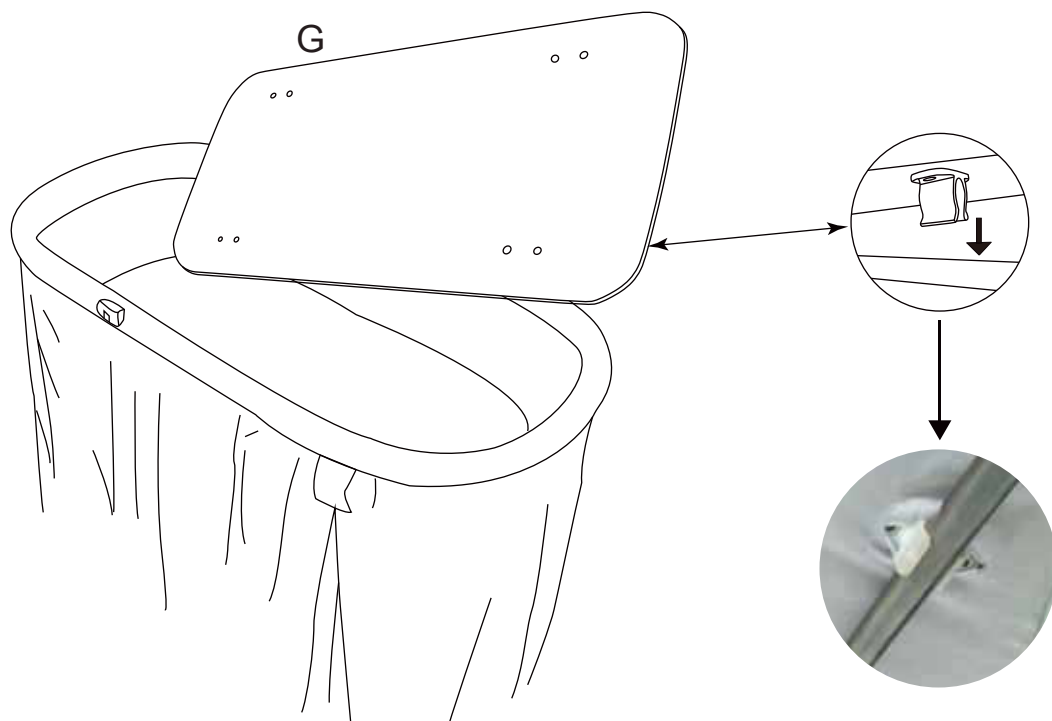

6

Put the FITTED SHEET (F) onto the VINYL/FOAM PAD (E) and insert into the BODY (B).

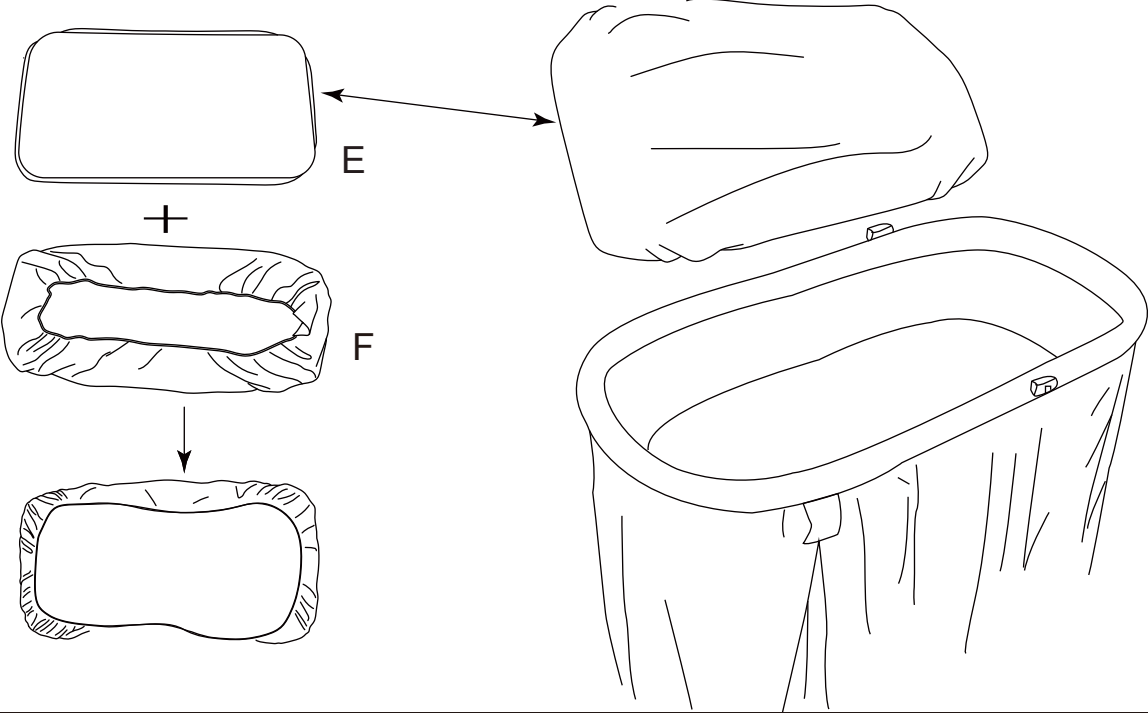

7

Fully insert the CANOPY (C) posts into the clips on the BODY (B).  
IF APPLICABLE TO YOUR MODEL: Thread the BELT (H) through the belt loops on the LINER/SKIRT (I) and tie the ends into a bow.

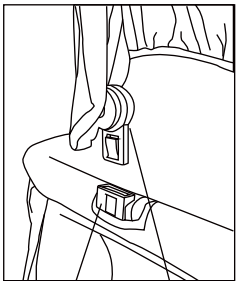

CLIP POST

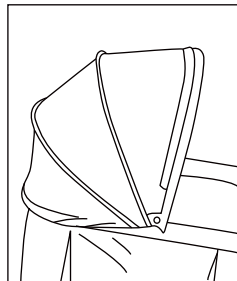
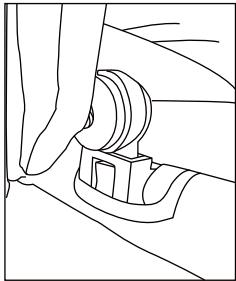

FINAL ASSEMBLY

